

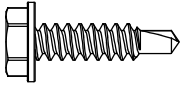



## Fastener Schedule for E-Class and Classic Colonials

Type 1	<ul style="list-style-type: none"> <li>-#10 x 3/4" Self Tapping Indented Hex Head, 18-8SS</li> <li>-5/16" Nut Driver</li> <li>-Qty: 12 per opening</li> </ul> <div style="display: flex; justify-content: space-around; align-items: center;">   </div>
Type 2	<ul style="list-style-type: none"> <li>-#10 x 3/4" Self Piercing Indented Hex Head, 18-8SS</li> <li>-5/16" Nut Driver</li> <li>-Qty: 8 per opening</li> </ul> <div style="display: flex; justify-content: space-around; align-items: center;">   </div>
Type 3	<ul style="list-style-type: none"> <li>-#8 x 3/4" Self Tapping Indented Hex Head, 18-8SS</li> <li>-1/4" Nut Driver</li> <li>-Qty: 10 per slide bolt</li> </ul> <div style="display: flex; justify-content: space-around; align-items: center;">   </div>

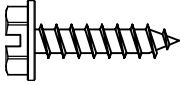

Back of shutter

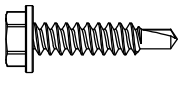
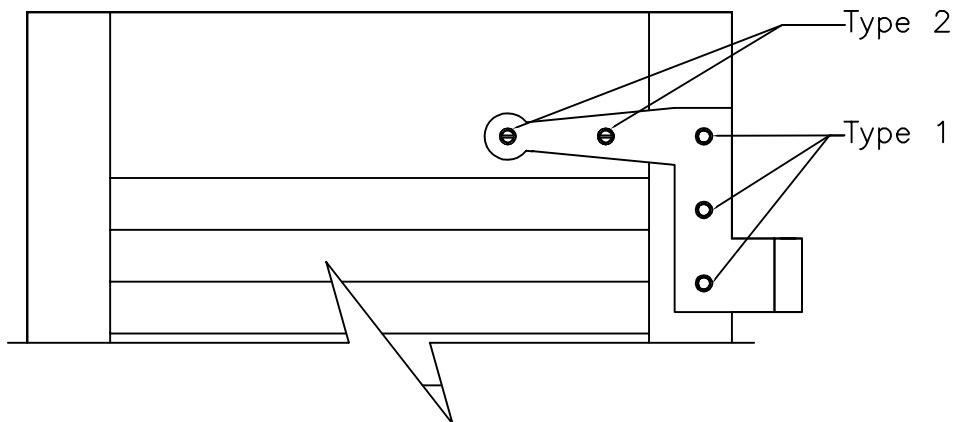
Figure  
1

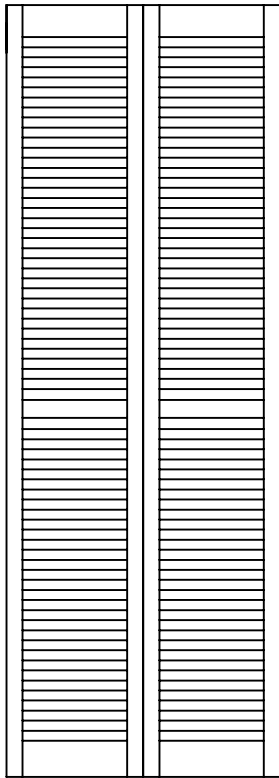

Place shutters face down on padded saw horses as shown. Note: Shutters with louvers have small screws on back side at outer corners (not shown).

Figure  
2

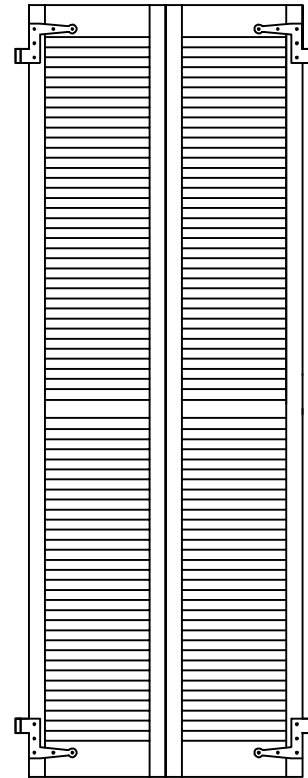

Place hinges on shutter, aligning edge of strap with edge of shutter. Secure straps with self tapping screws (stile) and self piercing screws (rail) using 5/16" nut driver. Note: use drill clutch to avoid breaking head off of self tapping screws.

Figure  
3

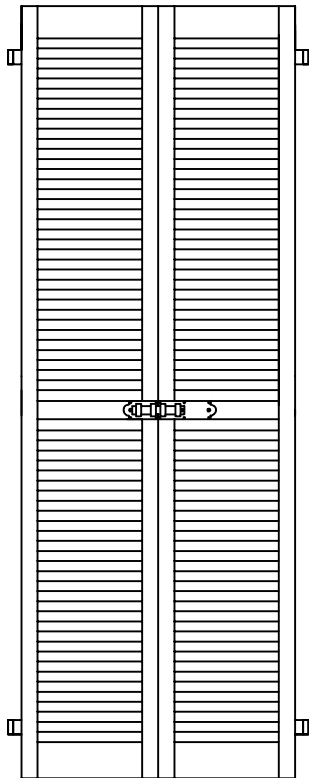

Flip Shutters over so they are face up and butt together as shown. Place slide bolt on center rail and secure using "Type 3" fastener.

Figure  
4

Embed Schedule	
Substrate	Recommended Anchor
Wood	#10 Deck Screw or Equivalent (2' or greater embed into Structure required)
Concrete	#10 Tapcon (1 3/4' or greater embed required)
Brick (Solid)	#10 Tapcon (1 3/4' or greater embed required)
Brick (Hollow, non Structural)	Holes must be thru drilled to access Structural Substrate
Block (Hollow, Structural)	#10 Epoxy Concrete Anchors of appropriate length, Toggles or Tapcons also acceptable

Using the table above, select an appropriate fastener for pintles. #10 x 2 1/2" deck screws (square drive) are supplied by default.

Figure 5

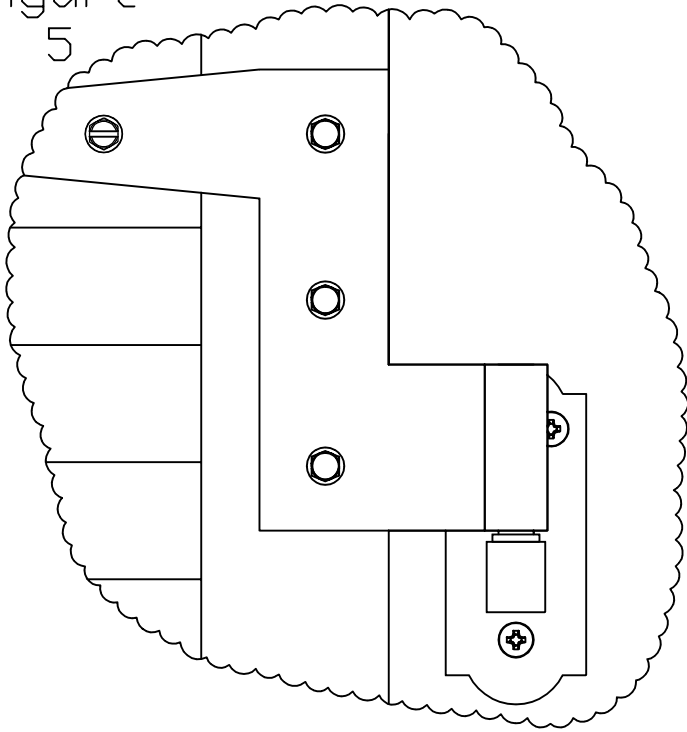

Measure and mark center of window sill. Place shutter on window sill with inside edge on center mark. Place shims under shutter to center vertically in opening. Place pintle in TOP strap and fasten to wall. Note: Only two holes will be accessible.

Figure 6

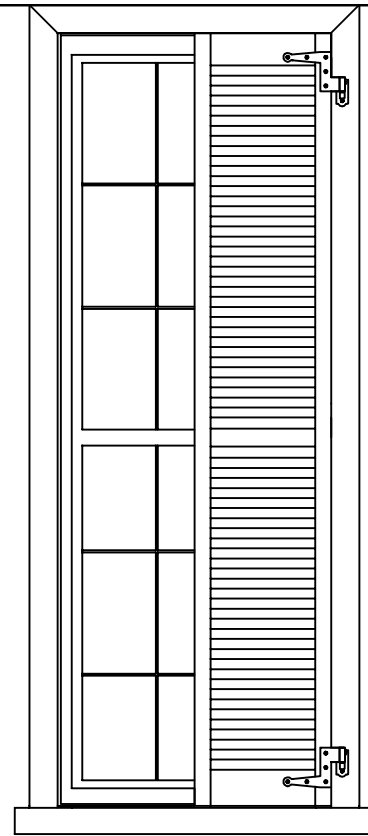

Secure remaining pintle(s). Place mating shutter in opening. Shim bottom and secure in same manner as first shutter.

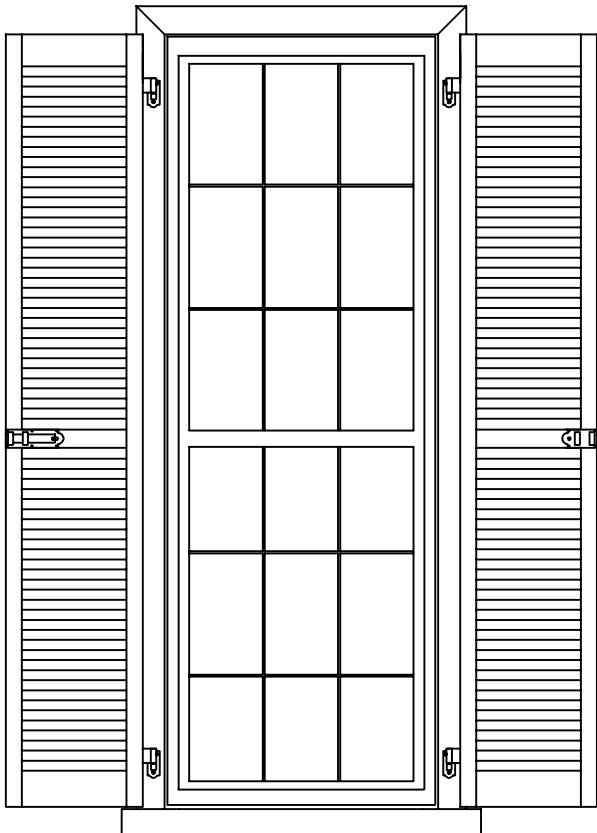

Open shutters and finish securing pintle(s). Check shutter operation and fit. Attach shutter hold backs.

Intentionally Blank